

**44.40600** ☞: 1

**6 way connection box supplied with: Protection cover, 6 way terminal, terminal cover and secondarylock.**

Air conditioner, Climatiser, Diesel Engine Plugs, Alternators, Starters, Automatic Gears, Electric Seats.

**A: (45.40601)** Housing, terminals, cover for terminals and Secondarylock.  
**B: (45.40602)** Protective cover.

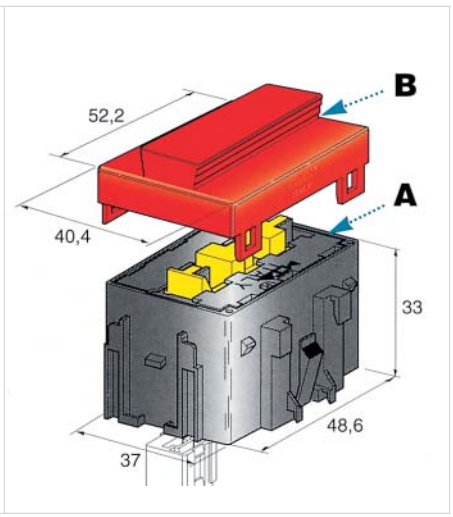

## Seal Connectors SUPERSEAL-1.5 mm

Material: PA 66

**11.05550-32**



**11.05560-32**



Male connectors



**44.23610**

1 way  
☞: 10 / 100

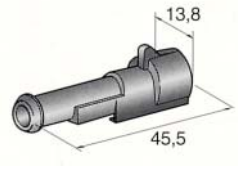

Female connectors



**44.23620**

1 way  
☞: 10 / 100

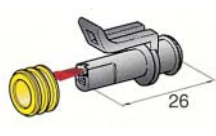

Male connectors



**44.23630**

2 way  
☞: 10 / 100

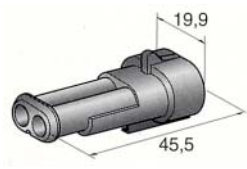

Female connectors



**44.23640**

2 way  
☞: 10 / 100

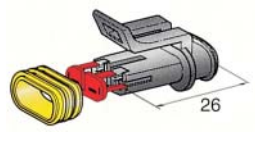



Male connectors



■44.23650

3 way  
⊞ : 10 / 100

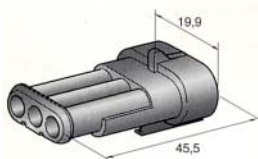

Female connectors



■44.23660

3 way  
⊞ : 10 / 100

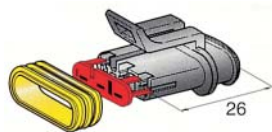

Male connectors



■44.23710

6 way  
⊞ : 5 / 50

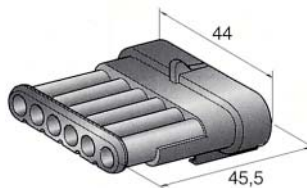

Female connectors

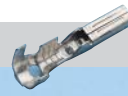

■44.23720

6 way  
⊞ : 5 / 50

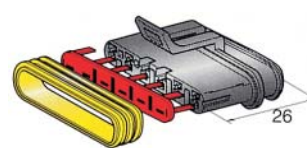

■44.23670

4 way  
⊞ : 5 / 50

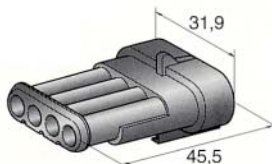

■44.23680

4 way  
⊞ : 5 / 50

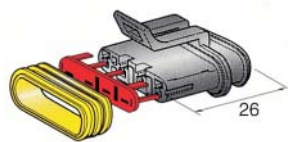

■44.23470

2 way  
⊞ : 10 / 100

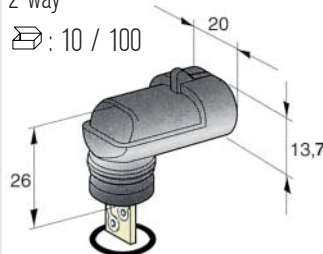

■44.23355

3 way  
⊞ : 5 / 50

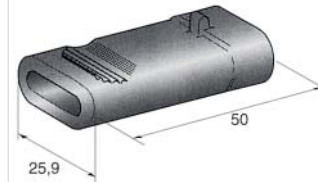

■44.23690

5 way  
⊞ : 5 / 50

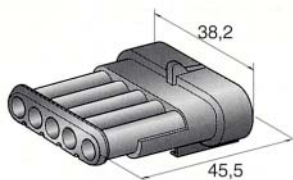

■44.23700

5 way  
⊞ : 5 / 50

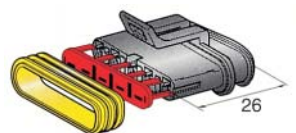





# Seal Connectors SUPERSEAL-2.8 mm

Male connectors



■44.23520

1 way

☞ : 5 / 50

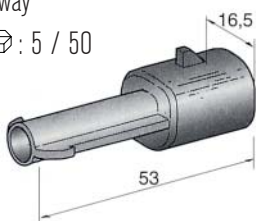

Female connectors



■44.23510

1 way

☞ : 5 / 50

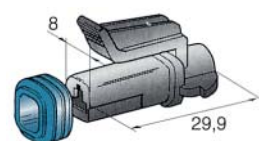

44.07740

Cable section: 0.5 a 1.5 mm<sup>2</sup>

Serie 1.5. Silicone - Superseal

☞ : 100 / 10000

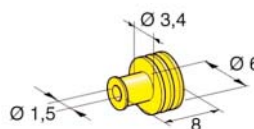

44.07510

Cable section: 0.5 a 1.5 mm<sup>2</sup>

Serie 2.8. Silicone

☞ : 50 / 5000

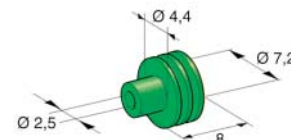

■44.23540

2 way

☞ : 5 / 50

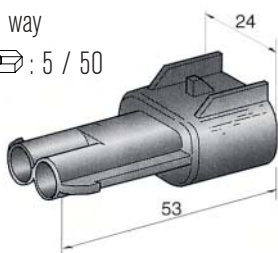

■44.23530

2 way

☞ : 5 / 50

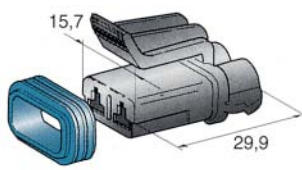

44.07530

Cable section: 0.5 a 1.5 mm<sup>2</sup>

Serie 1.5. Silicone - Superseal

☞ : 50 / 5000



For use with electronic injection connectors

44.10662

Cable section: 0.5 a 1 mm<sup>2</sup>

Silicone

☞ : 10 / 100



■44.23560

3 way

☞ : 5 / 50

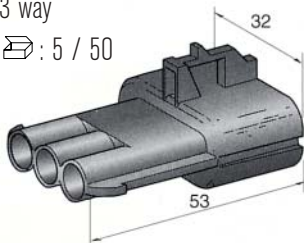

■44.23550

3 way ☞ : 5 / 50

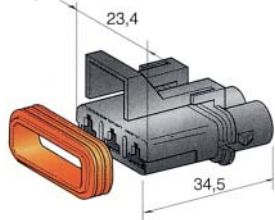

For use with electronic injection connectors

44.10658

Cable section: 0.5 a 1.5 mm<sup>2</sup>

Silicone. ☞ : 10 / 100



For use with electronic injection connectors

44.10659

Cap

☞ : 10 / 100

7 Connection - Protection - Cable Marking