

Fig. 1

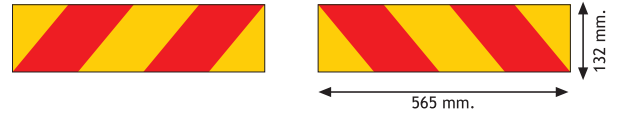

Fig. 1: Kit 2 paneles para camión.

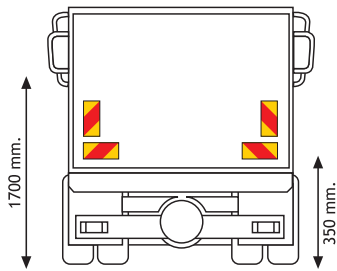

Fig. 2

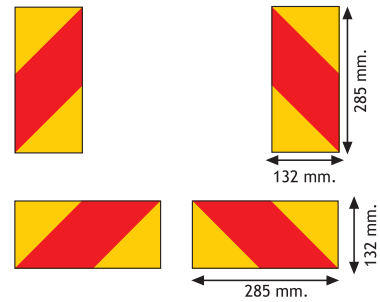

Fig. 2: Kit 4 paneles para camión.

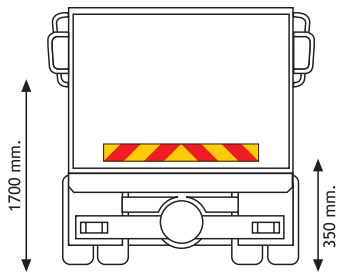

Fig. 3

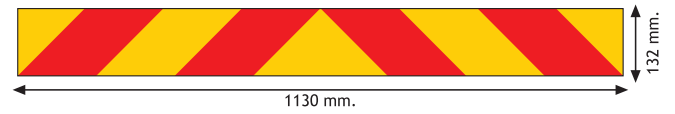
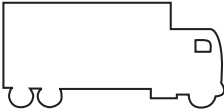

Fig. 3: Panel para camión.

| Panel para camión ≥ 3500 Kg. | Panel de aluminio | | | | Autoadhesivo | |
|--|-------------------|---------|-----------|---------|--------------|-------|
| | ↘ 0,8 mm. | ↘ 1 mm. | ↘ 1,2 mm. | ↘ 2 mm. | | |
|  | Fig. 1 | 90044 | 90054 | 90084 | 90070 | 99201 |
| | Fig. 2 | 90042 | 90052 | 90085 | 90081 | 99202 |
| | Fig. 3 | - | 90097 | 90087 | 90075 | 99203 |

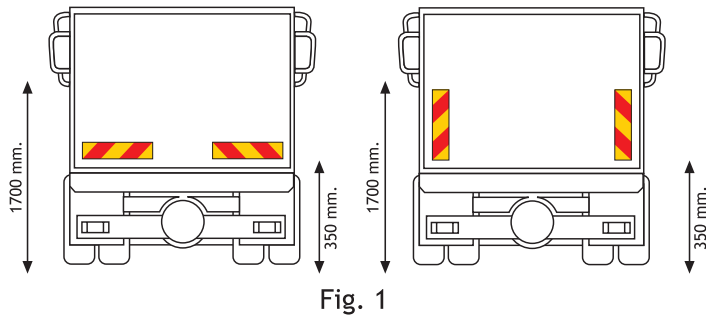

Fig. 1

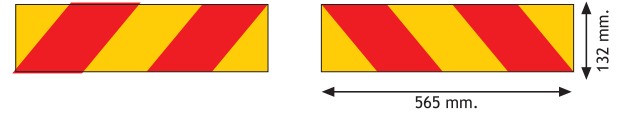

Fig. 1: Kit 2 paneles para camión.

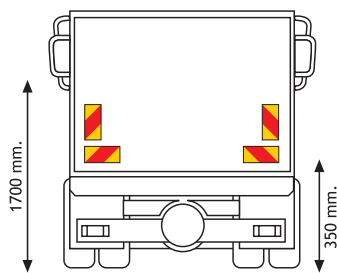

Fig. 2

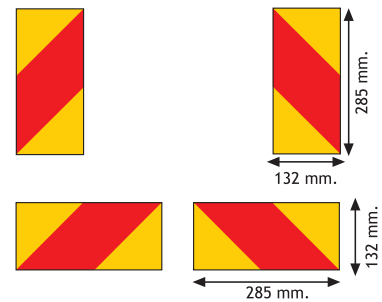

Fig. 2: Kit 4 paneles para camión.

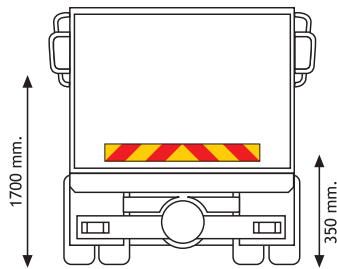

Fig. 3

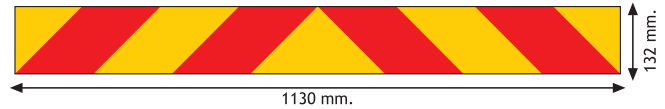

Fig. 3: Panel para camión.

REFLECTANTE/ REFLECTANTE -RR-

| Panel para camión ≥ 3500 Kg. | Panel de aluminio | | | | Autoadhesivo |
|---------------------------------|-------------------|---------|-----------|---------|--------------|
| | ✂ 0,8 mm. | ✂ 1 mm. | ✂ 1,2 mm. | ✂ 2 mm. | |
| Fig. 1 | 90151 | 90154 | 90095 | 90157 | 99204 |
| Fig. 2 | 90152 | 90155 | 90086 | 90158 | 99205 |
| Fig. 3 | - | 90156 | 90088 | 90159 | 99206 |

REFLECTANTE/ FLOURESCENTE -RF-

| Panel para camión ≥ 3500 Kg. | Panel de aluminio | | | | Autoadhesivo |
|---------------------------------|-------------------|---------|-----------|---------|--------------|
| | ✂ 0,8 mm. | ✂ 1 mm. | ✂ 1,2 mm. | ✂ 2 mm. | |
| Fig. 1 | 90160 | 90163 | 90094 | 90168 | 99207 |
| Fig. 2 | 90161 | 90164 | 90166 | 90169 | 99208 |
| Fig. 3 | - | 90165 | 90167 | 90170 | 99209 |

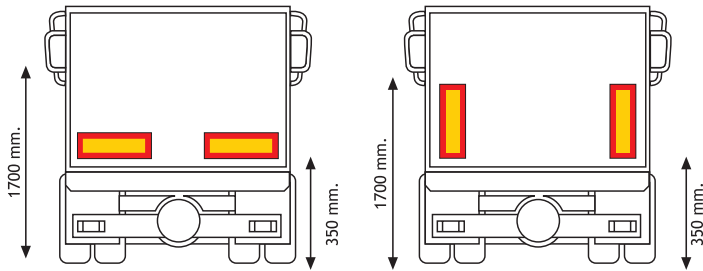

Fig. 4

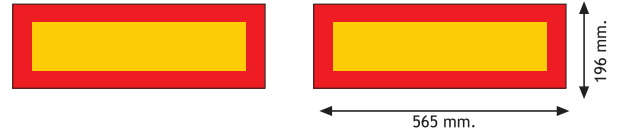

Fig. 4: Kit 2 paneles para remolque.

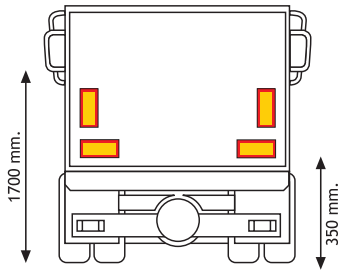

Fig. 5

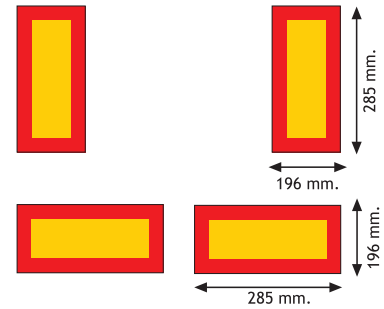

Fig. 5: Kit 4 paneles para remolque.

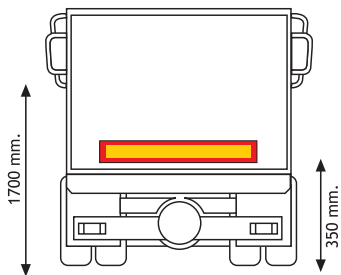

Fig. 6

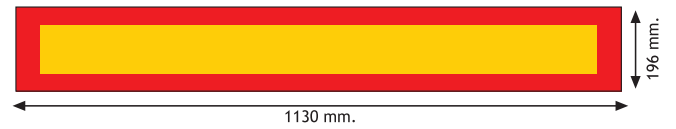

Fig. 6: panel para remolque.

| Panel para remolque ≥ 3500 Kg. | Panel de aluminio | | | | Autoadhesivo |
|-----------------------------------|-------------------|---------|-----------|---------|--------------|
| | ∩ 0,8 mm. | ∩ 1 mm. | ∩ 1,2 mm. | ∩ 2 mm. | |
| Fig. 4 | 90043 | 90053 | 90083 | 90069 | 99211 |
| Fig. 5 | 90041 | 90051 | 90089 | 90082 | 99212 |
| Fig. 6 | - | 90098 | 90091 | 90077 | 99213 |

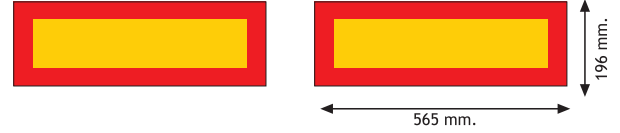
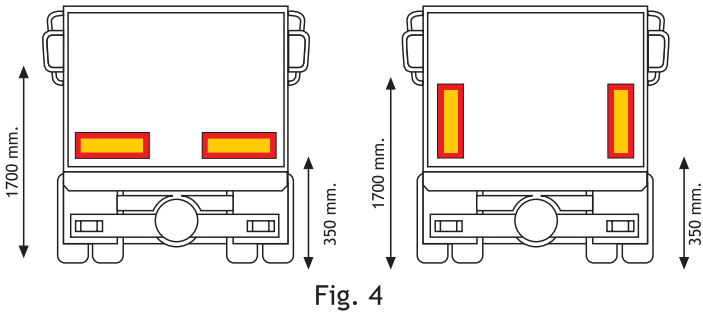

Fig. 4: Kit 2 paneles para remolque.

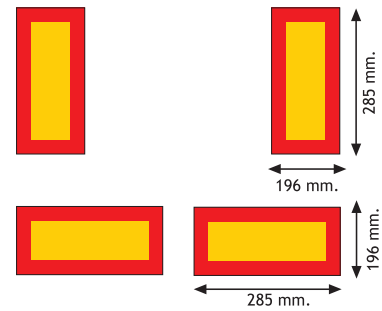
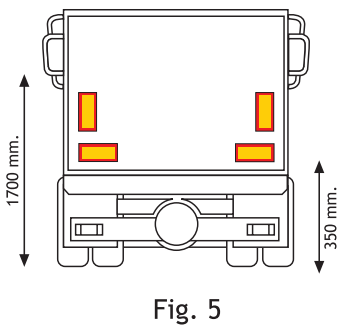

Fig. 5: Kit 4 paneles para remolque.

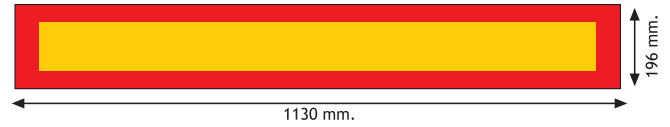
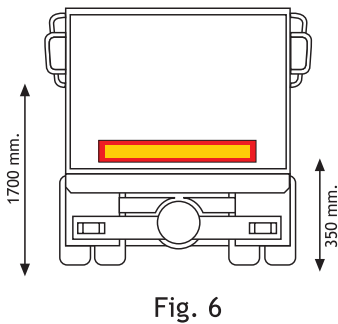

Fig. 6: panel para remolque.

REFLECTANTE/ REFLECTANTE -RR-

| Panel para remolque ≥ 3500 Kg. | Panel de aluminio | | | | Autoadhesivo |
|-----------------------------------|-------------------|---------|-----------|---------|--------------|
| | ✂ 0,8 mm. | ✂ 1 mm. | ✂ 1,2 mm. | ✂ 2 mm. | |
| Fig. 4 | 90171 | 90174 | 90096 | 90177 | 99214 |
| Fig. 5 | 90172 | 90175 | 90090 | 90178 | 99215 |
| Fig. 6 | - | 90176 | 90092 | 90179 | 99216 |

REFLECTANTE/ FLOURESCENTE -RF-

| Panel para remolque ≥ 3500 Kg. | Panel de aluminio | | | | Autoadhesivo |
|-----------------------------------|-------------------|---------|-----------|---------|--------------|
| | ✂ 0,8 mm. | ✂ 1 mm. | ✂ 1,2 mm. | ✂ 2 mm. | |
| Fig. 4 | 90180 | 90183 | 90093 | 90188 | 99217 |
| Fig. 5 | 90181 | 90184 | 90186 | 90189 | 99218 |
| Fig. 6 | - | 90185 | 90187 | 90190 | 99219 |